

SDD2-40-130

**SDD2 for IT systems**

Novaris SDD2 surge diverters provide surge protection for two phase, balanced AC power feeds and for DC supplies that may not necessarily have one polarity earthed. The SDD2 provides both common and transverse mode protection with earth leakage current in the microamp range. The SDD2 is housed in a DIN compliant fail-safe metal enclosure.

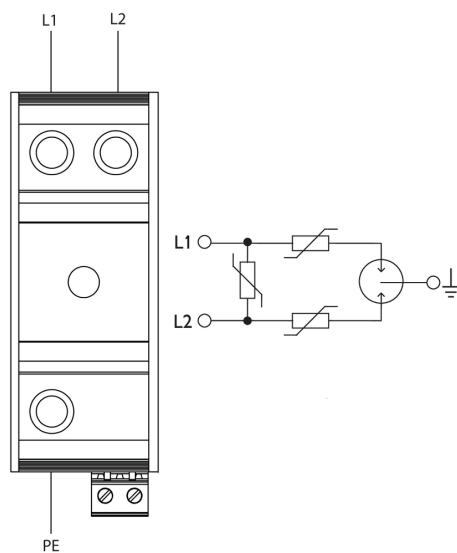

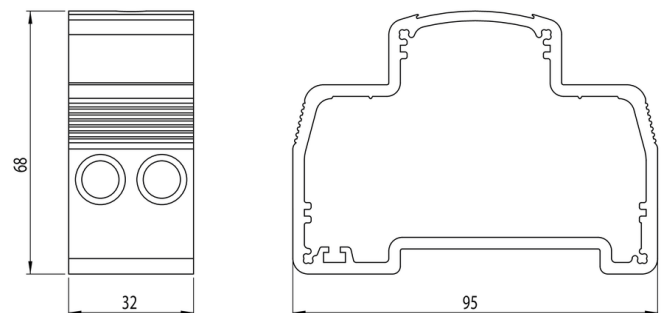

Wiring**Dimensions****Standards**

IEC 61643-21

SPD connected to telecommunications and signaling networks

Specifications

Electrical Specifications

Connection type		Shunt
Modes of protection		L-L, L-PE
Number of phases		2
Nominal voltage	U_0	110VAC
Recommended backup fuse		32A
Earth leakage current	I_{PE}	<10 μ A



Electrical (L-L) Specifications

Maximum continuous voltage AC	U_c	130VAC
Maximum continuous voltage DC	U_c	155VDC
Maximum discharge current (8/20 μ s)	I_{max}	40kA
Nominal discharge current (8/20 μ s)	I_n	20kA
Voltage protection level (3kA 8/20 μ s)	U_p	<370V
Response time	t_A	<5ns















Electrical (L-PE) Specifications

Maximum discharge current (8/20 μ s)	I_{max}	20kA
Nominal discharge current (8/20 μ s)	I_n	10kA
Total current		40kA
Voltage protection level (3kA 8/20 μ s)	U_p	<440V
Voltage protection level (1kV/ μ s)	U_p	<360V
Response time	t_A	<5ns

Indication Specifications

Display		LED power and thermal failure
Alarm		Passive alarm
Alarm isolation		4kV

Mechanical Specifications

Minimum operating temperature		-40°C
Maximum operating temperature		70°C
Minimum operating humidity		5%
Maximum operating humidity		95%
Mounting method		TS35 DIN Rail
Environmental rating		IP20
Enclosure material		Aluminium
Enclosure finish		Black powdercoat
Terminal capacity - power		16mm ²
Terminal screw torque - power		2Nm
Terminal capacity - alarms		2.5mm ²
Terminal screw torque - alarms		0.5Nm
Length		95mm
Width		36mm
Height		70mm

Other Specifications

Product Code  SDD2-40-130

Shipping Specifications

Weight  200g