

SDN3-150-275



All Mode Surge Diverter

Use MULTIMOV all mode high energy surge diverters for point of entry protection at main switchboards, especially where N-PE protection is required.

Redundant Segments

MULTIMOV surge diverters feature a parallel redundant arrangement of high energy metal oxide varistors (MOVs), thus promoting long life and exceptional surge handling capacity. In the event of a varistor failure the remaining segments continue to provide protection.

LED Status Active Display

The LED display indicates segment status and indicates normal operation when all LEDs are brightly lit. A dim LED phase segment indicates the failure of an external backup fuse and this will activate the external alarm. An extinguished LED indicates a component failure or thermal overload, also activating the external alarm.

Safe Metal Enclosure

Novaris power protection products are housed in safe, all metal enclosures. In the event of a prolonged overvoltage they will not catch fire or explode.

Wiring

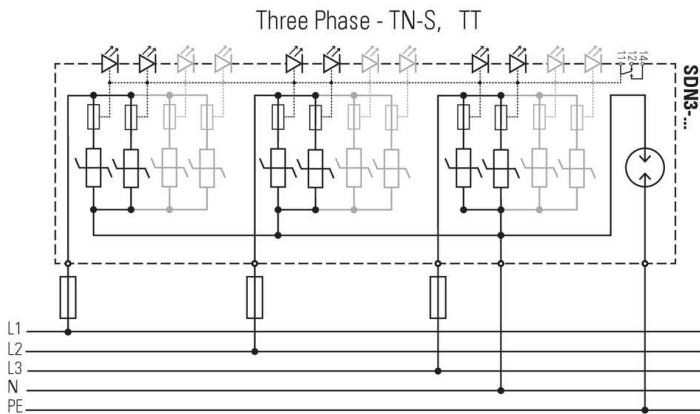

Dimensions

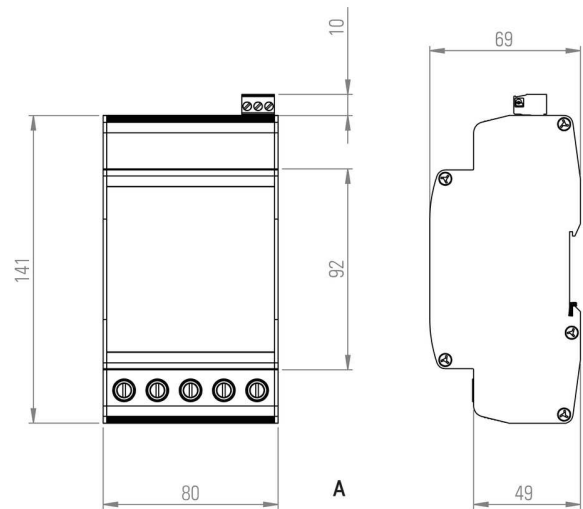





Standards

- IEC 61643-11:2011 SPD connected to low-voltage power systems - Type 1+2
- AS/NZS 1768:2007 A.C. power system SPD - Cat C, B
- UL 1449 3rd edition Low voltage SPD - Type 2
- IEEE 62.41.2:2002 Low voltage SPD - Cat B

Product Datasheet

Electrical Specifications

Connection type		Shunt
Modes of protection		L-N, N-PE
Number of ports		1
Number of phases		3
Location		Indoor
Nominal voltage	U_0	230VAC
Short circuit withstand level	I_{SSCR}	25kA
Maximum backup fuse		80A
Recommended SCB		SCB1-3-25
Earth leakage current	I_{PE}	<10 μ A



Electrical (L-N) Specifications

Maximum continuous voltage AC	U_c	275VAC
Maximum discharge current (8/20 μ s)	I_{max}	150kA
Nominal discharge current (8/20 μ s)	I_n	60kA
Lightning impulse current (10/350 μ s)	I_{imp}	18.75kA
Voltage protection level (3kA 8/20 μ s)	U_p	<750V
Voltage protection level (In)	U_p	1450V
Response time	t_A	<25ns
Voltage withstand (5s)	U_T	335V















Electrical (N-PE) Specifications

Maximum continuous voltage	U_c	255VAC
Maximum discharge current (8/20 μ s)	I_{max}	150kA
Lightning impulse current (10/350 μ s)	I_{imp}	50kA
Nominal discharge current (8/20 μ s)	I_n	100kA
Voltage protection level (1kV/ μ s)	U_p	<1000V
Voltage protection level (3kA 8/20 μ s)	U_p	<1200V
Response time	t_A	<100ns
Voltage withstand (200ms)	U_T	1200V
Follow current interrupt rating	I_{fi}	100A

Indication Specifications

Display		LED power and thermal failure
Alarm		SPDT power and thermal failure
Alarm isolation		4kV

Mechanical Specifications

Minimum operating temperature		-40°C
Maximum operating temperature		70°C
Minimum operating humidity		5%
Maximum operating humidity		95%
Mounting method		TS35 DIN Rail/Optional Panel kit
Environmental rating		IP20
Enclosure material		Aluminium
Enclosure finish		Black Powdercoat
Terminal capacity - power		16mm ²
Terminal screw torque - power		2Nm
Terminal capacity - alarms		2.5mm ²
Terminal screw torque - alarms		0.5Nm
Length		141mm
Width		80mm
Height		69mm

Other Specifications

Product Code  SDN3-150-275

Shipping Specifications

Weight		870g
Customs tariff		85363000, 85363010